

## Bendini

Efficient spinal rod bending  
to achieve alignment



# Integrated Global Alignment (iGA)

## Why alignment matters

Current and emerging data illustrate a direct correlation between spinal alignment and long-term clinical outcomes.<sup>1</sup> Specific spinopelvic parameters, including the proportionality of pelvic incidence (PI) and lumbar lordosis (LL), are key predictors in determining successful patient outcomes in all spinal procedures from single- to multi-level pathologies. NuVasive is committed to a global approach for assessing, preserving, and restoring spinal alignment in an effort to promote surgical efficiencies, lasting patient outcomes and improved quality of life.

### Alignment matters.



#### Calculate

Preoperatively evaluate alignment parameters to create a reliable plan with clear alignment goals.



#### Correct

Receive immediate intraoperative feedback on alignment, with the industry's only real-time intraoperative assessment tool, to help confirm alignment goals are achieved and maintained.



#### Confirm

Postoperatively confirm the success of the procedure's effect on alignment by reviewing surgical results and comparing them to the surgical plan.

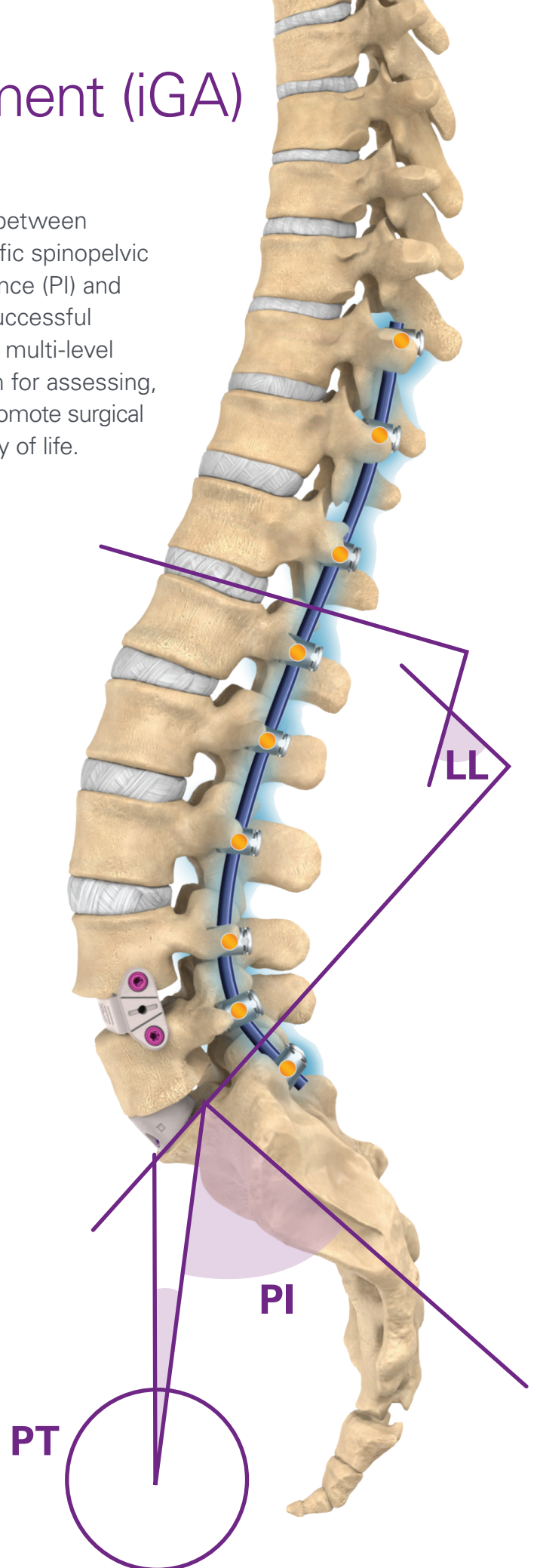

# Restoration for a malaligned spine

The Bendini spinal rod bending system offers correction tools, which can assist in complex degenerative deformity cases.

## The procedure is designed to benefit surgeons and patients with:



### Restored alignment

- Surgeon-driven menus enable rapid intraoperative alignment assessment and rod customization.
- Coronal and sagittal design tools help guide surgeons to achieve alignment goals prior to exiting the OR.



### Intraoperative flexibility

- Real-time rod bending provides the surgeon with the ability to modify rod bends at any time during the case.
- Bender adaptability allows the surgeon to bend 5.5 or 6.0 mm rods.

## Streamline advanced cases with Bendini

### Tumors and trauma

By bending the rod to implant locations, Bendini-bent rods exert less force on the bone-screw interface,<sup>2</sup> which may reduce the potential of screw pull-out.

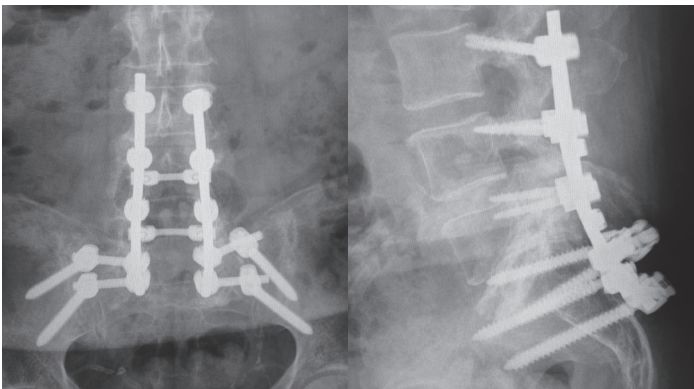

### Adjacent segment fixation (ASF)

Simplify revision surgery with the ASF pointer by digitizing around ASF connectors and creating a custom "Z" rod.

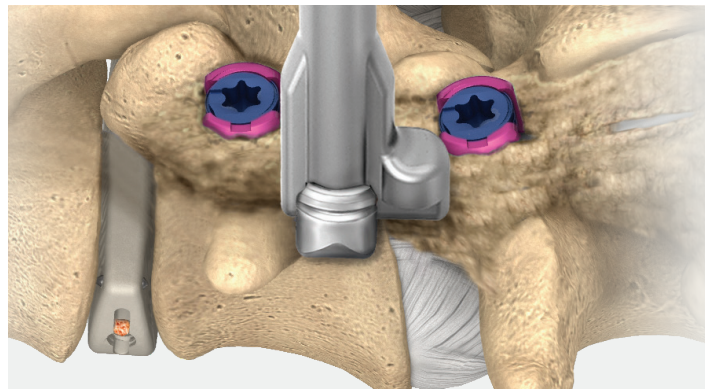

### Posterior column osteotomies

Utilize the lock screw pointer to digitize on top of the 3CO rack and maintain correction post-osteotomy.

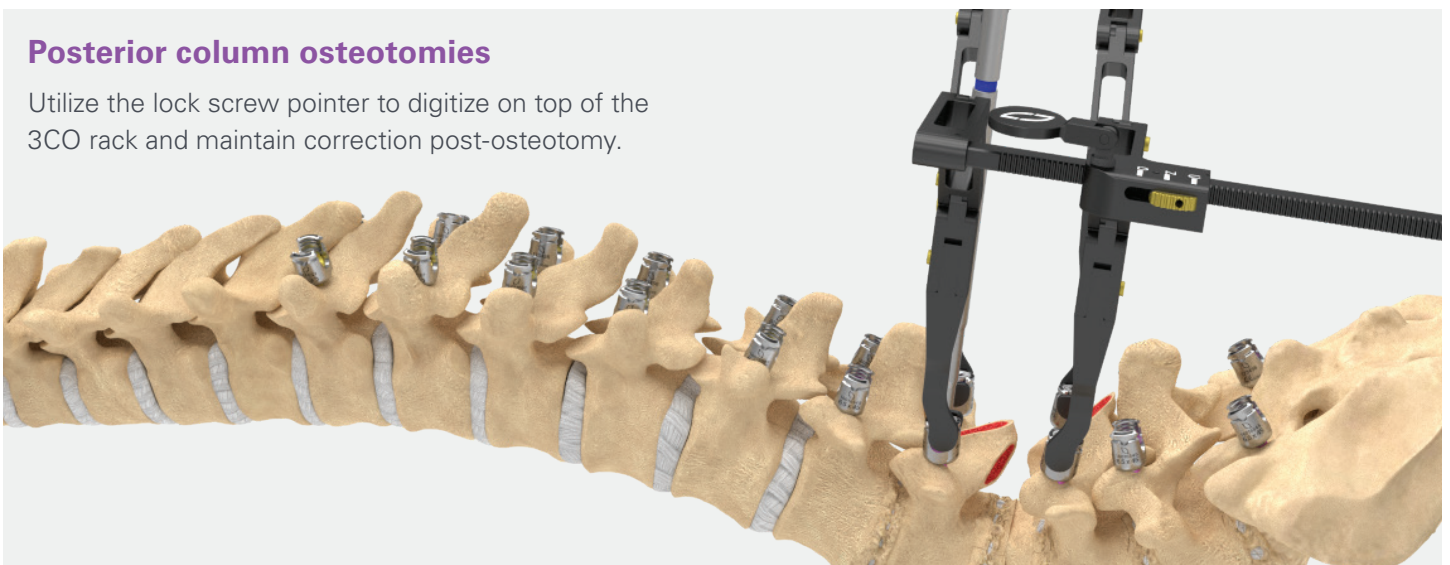



# Correction features utilizing iGA assessment

**iGA assessment** is an NVM5 software application which enables intraoperative assessment of various patient anatomical parameters, like LL, through the use of lateral fluoroscopic images.



Sagittal bending tool

iGA assessment

Coronal straightening option

**Tip:** The sagittal alignment assessment tool (PI minus LL indicator) is displayed in both iGA assessment and on the Bendini rod preview screen. When used in conjunction with iGA assessment, the PI minus LL display in the Bendini application helps to facilitate quantified and informed sagittal rod bending to assist in restoring alignment.

## Surgeon-driven application to customize rods with Bendini

### Sagittal bending tool

Surgeon-driven menu enables rod customization in the sagittal plane to help achieve sagittal alignment.

#### Menu options include:

- lumbar lordosis—evenly distributes lordosis across a segment;
- 1/3, 2/3 lumbar lordosis—splits distribution of lordosis values between 1/3 and 2/3 of defined points; and
- thoracic kyphosis—evenly distributes kyphosis across a defined segment.

### Coronal straightening option

Surgeon-driven menu enables customized rod straightening in the coronal plane.

#### Straightening options include:

- 25% to line,
- 50% to line,
- 75% to line, and
- 100% straight (no coronal bends).

# Preservation for an aligned spine

The **Bendini** spinal rod bending system is used to create customized rods which are bent exactly to implant locations. The system expedites manual rod manipulation via computer-assisted bend instructions, designed to benefit surgeons and patients with:

## Decreased OR time

Predictable, reproducible rod bending helps surgeons create rods which often require only a single pass.<sup>3</sup>

## Reduced screw strain

Implant-specific rods are designed to minimize forces on the screw bone interface and prevent unnecessary preloading of the construct.<sup>2</sup>

## Minimized residual rod overhang

Custom overhang enables accurate rod length.<sup>3</sup> Excess rod overhang may lead to potential adjacent-level facet impingement.

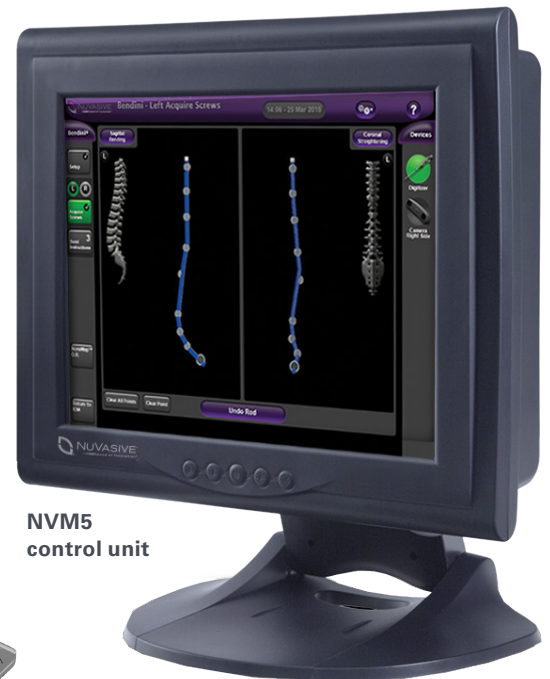
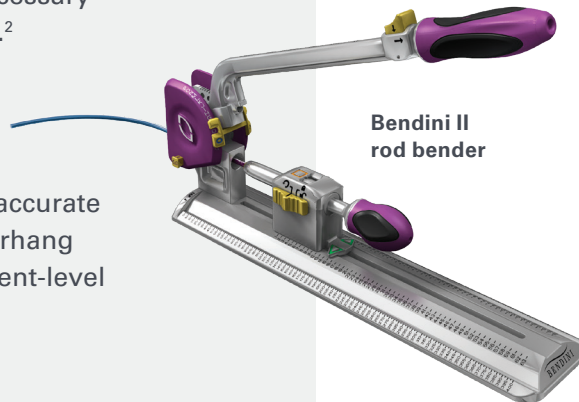

## Decreased reduction force required with Bendini<sup>2</sup>

- The average residual screw forces, which indicate potential for postoperative screw pullout or loosening, were **60% less with Bendini** than with manual rod bending.
- The proportion of screws with reduction force peaks greater than 500 N, which may lead to intraoperative screw pullout, was **0% with Bendini** and 20% with manual rod bending.
- The proportion of screws with reduction force peaks greater than 300 N, which may lead to intraoperative screw pullout in compromised bone, was **5% with Bendini** and 39% with manual rod bending.

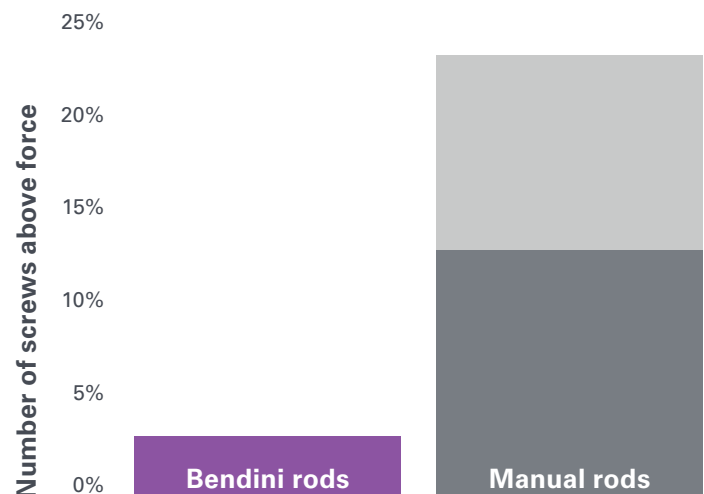







# Paired technology

## Single-platform integration

**NVM5** is the NuVasive platform for surgical efficiency, intraoperative alignment assessment and neuromonitoring technologies. This system combines all of these capabilities into one minimal footprint, specifically designed to support the unique requirements of spine surgery.

### Procedurally integrated neuromonitoring

Comprehensive suite of intraoperative neuromonitoring modalities designed to promote positive neurological outcomes

- Real-time information on nerve proximity when placing screws with dynamic electromyography (EMG)
- Continuous monitoring for mechanical disturbances to nerve structures with free-run EMG
- Combined somatosensory evoked potential and motor evoked potential monitoring for a reliable method of monitoring spinal cord function with greater sensitivity and predictability than single-modality techniques



## Evolving posterior fixation technology within the iGA platform

The **Reline** portfolio is the evolution of posterior fixation technology within the iGA platform. Reline provides integrated open and maximum access surgery (MAS) procedural solutions, delivering a highly efficient surgical experience to help drive reproducible patient outcomes.

### Surgical efficiency

Universal open and MAS solutions created to help deliver an enhanced surgical experience

- Fully compatible open and MAS instrumentation
- Seamless integration with NuVasive Power instruments and NVM5
- Streamlined rod insertion facilitated by the Bendini spinal rod bending system

### Operative reliability

Multiple surgical options designed to provide dependable strength

- Patented Helical Flange locking technology providing reliable performance
- Rigid instrument engagement delivering intraoperative dependability
- Multi-functional instruments offer a flexible approach to help with challenging procedures

### Procedural versatility

Pathology-based instrumentation to approach a variety of surgical techniques

- Implants accommodate multiple rod diameters and materials
- Anatomically designed kyphotic, lordotic and tapered diameter rods

## Case report

# Lumbar degenerative scoliosis (30° Cobb angle), L4 spondylolisthesis, degenerative disc disease

**Surgeon:** Richard Wupperman, M.D. from Lakeway Regional Medical Center, Lakeway, TX, USA

**NuVasive procedure:** T10—pelvis posterior, MAS fixation with Precept and Bendini

### Detailed problem list

- 72-year-old female
- Lumbar degenerative scoliosis (30° Cobb angle), L4 spondylolisthesis and degenerative disc disease

### Postoperative

- 1 month later—nearly pain-free, no longer taking narcotics, walking ¼ mile per day
- 3 months later—walking 3 miles per day

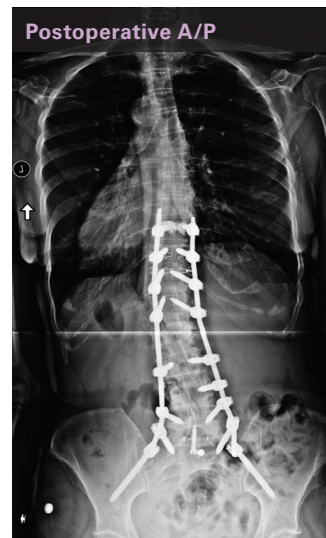

### References

1. Terran J, Schwab F, Shaffrey CI, et al. The SRS-Schwab adult spinal deformity classification: assessment and clinical correlations based on a prospective operative and nonoperative cohort. *Neurosurg* 2013;73(4):559-68.
2. Tohmeh AG, Isaacs RE, Dooley ZA, et al. Long construct pedicle screw reduction and residual forces are decreased using a computer-assisted rod bending system. *Spine J* 2014;14(11 Suppl):S143-S144.
3. Wupperman RM, Isaacs RE, Taylor WR. The Bendini spinal rod bending system for long percutaneous pedicle screw constructs: cadaveric utility study and early clinical experience. Society of Lateral Access Surgery (SOLAS®) 2013 Annual Meeting. San Diego, CA, USA.

**NuVasive, Inc.**  
7475 Lusk Blvd., San Diego, CA 92121 USA  
+1 800.475.9131

**NuVasive Netherlands B.V.**  
Jachthavenweg 109A, 1081 KM Amsterdam, The Netherlands  
+31 20 72 33 000

©2019. NuVasive, Inc. All rights reserved. 9501357 D

[nuvative.com](http://nuvative.com)



CE 2797